

## VERONA \_STARWHITE

Il modello Verona riprende il pratico ed apprezzato sistema di apertura e chiusura telescopico, tramite asta, del Capri.

È stato progettato reinterpretando la robustezza della struttura alle misure proposte ed è dotato di un palo diametro 80 mm. Le innovazioni sui componenti utilizzati ne facilitano l'utilizzo, rendendolo ideale per un impiego professionale in ambienti contract come dehor di hotel, ristoranti e bar.

Pensato per rispondere alle esigenze del settore HoReCa, unisce affidabilità, praticità e un design contemporaneo, assicurando massima resistenza e durata nel tempo.

### EN

The new Verona takes the practical and popular telescopic opening and closing system, using the rod of the Capri.

It was designed by reinterpreting the sturdiness of the structure to the proposed dimensions and is equipped with an 80 mm diameter pole. Innovations on the components used enable an easy use, making it ideal for professional application in contract environments such as hotel, restaurant and bar terraces. Designed to meet the needs of the HoReCa sector, it combines reliability, practicality and contemporary design, ensuring maximum strength and durability





#### DE

Das Modell Verona uebernimmt Capri's praktisches und geschaeztes teleskopische Oeffnungs- und SchlieÙsystem mit Stange. Bei der Konstruktion wurde die Staerke des Gestells den moeglichen Massen verhaeltnismaessig angepasst und wurde mit einem 80mm Durchmesser Mast ausgestattet. Die Innovationen der verwendeten Komponenten erleichtern den Einsatz und eignen sich daher fuer den professionellen Einsatz im Objektbereich, sowie fuer die Aussenbereiche von Hotels, Restaurants und Bars. Entwickelt, um den Anforderungen des Gastrobereiches gerecht zu werden, vereint es Zuverlaessigkeit, Zweckmaessigkeit und modernes Design und gewaehrleistet somit eine maximale Widerstandsfahigkeit und Langlebigkeit im Laufe der Zeit.

#### FR

Le modèle Vérone reprend le système d'ouverture et de fermeture télescopique, via tige, pratique et apprécié, du Capri. Il a été conçu en réinterprétant la robustesse de la structure aux mesures proposées. Il est équipé d'un mât de 80 mm. de diamètre. Les innovations sur les composants utilisés facilitent son utilisation, le rendant idéal pour une utilisation professionnelle dans des environnements contractuels tels que les espaces extérieurs des hôtels, restaurants et bistros. Conçu pour répondre aux besoins du secteur HoReCa, il allie fiabilité, praticité et design contemporain, garantissant une résistance et une durabilité maximales dans le temps.

#### ES

El modelo Verona retoma el práctico y apreciado sistema telescópico de apertura y cierre mediante barra de hierro, del Capri. Fue diseñado reinterpretando la robustez de la estructura a las medidas propuestas y está equipado con un poste de 80 mm de diámetro. Las innovaciones en los componentes utilizados facilitan su uso, haciéndolo ideal para un uso profesional en entornos Contract como hoteles, restaurantes y bares. Diseñado para satisfacer las necesidades del sector Ho.Re.Ca, combina fiabilidad, practicidad y un diseño contemporáneo, garantizando la máxima resistencia y durabilidad en el tiempo.

#### NL

Het model Verona maakt gebruik van Capri's praktische en gewaardeerde telescopische openings- en sluitsysteem met stang. In het ontwerp is de sterkte van het frame proportioneel aangepast met een mast met een diameter van 80 mm. De innovaties in de gebruikte componenten vergemakkelijken het gebruik en daarom zijn deze parasols zeer geschikt voor professioneel gebruik in de horeca, dus past de Verona perfect op terrassen van hotels, restaurants en bars. Ontworpen om te voldoen aan de hoge eisen van de horecasector, combineert Verona betrouwbaarheid, functionaliteit en modern design, waardoor een maximale stevigheid en duurzaamheid in de loop van de tijd wordt gegarandeerd.



300x300 | 350x350  
400x400 | 500x500





**IT**  
Telaio con sistema di apertura telescopico in alluminio. Viteria in acciaio inox e componenti in nylon colore nero o bianco.

**EN**  
Frame with telescopic aluminium opening system. Stainless steel hardware with black or white nylon components.

**DE**  
Aluminiumgestell mit Teleskop-Oeffnungssystem. Edelstahlschrauben und schwarze oder weisse Nylonkomponenten.





**FR**  
Armature avec système d'ouverture télescopique en aluminium. Vis en acier inoxydable et composants en nylon noir ou blanc.

**ES**  
Estructura con sistema de apertura telescópico en aluminio. Tornillos de acero inoxidable y componentes de nailon negro o blanco.







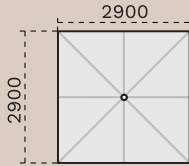
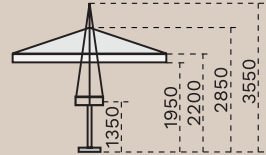
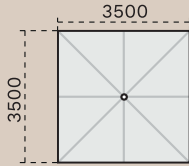
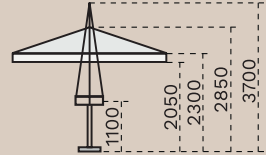
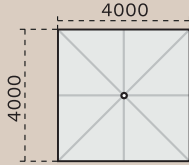
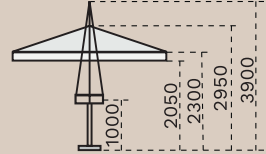
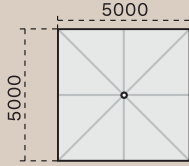
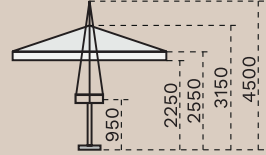

**NL**  
Aluminium frame met telescopisch openingssysteem. Roestvrijstalen schroeven en zwarte of witte nylon onderdelen.



## CHARACTERISTICS

				<b>KG</b>	<b>M<sup>3</sup></b>				
3,0 x 3,0	DARK C3030VTD STARWHITE C3030VTW			31	0,21	80	8	20x40	
3,5 x 3,5	DARK C3535VTD STARWHITE C3535VTW			34	0,23	80	8	20x40	
4,0 x 4,0	DARK C4040VTD STARWHITE C4040VTW			37	0,25	80	8	20x40	
5,0 x 5,0	DARK C5050VTD STARWHITE C5050VTW			48	0,30	80	8	20x40	

## FINISHING

-  Camino antivento  
Wind cap
-  Sistema telescopico  
Telescopic system
-  Alu Dark
-  Alu Starwhite
-  Stecca con sistema "easy change"  
Ribs with "easy change" system
-  Alu Dark
-  Alu Starwhite
-  INOX
-  Viteria in inox  
Screws in Stainless steel
-  Cataforesi  
Cataphoresis

## OPTIONAL

		BASES p. 226	BALLAST p. 234	GROUND FIXING p. 235
3,0 x 3,0	DARK C3030VTD STARWHITE C3030VTW	PL1DS PL1BS	BQ8080DS BQ8080ZS	BUD26DS BUD26WS
3,5 x 3,5	DARK C3535VTD STARWHITE C3535VTW	PL1DS PL1BS	BQ8080DS BQ8080ZS	BUD26DS BUD26WS
4,0 x 4,0	DARK C4040VTD STARWHITE C4040VTW	PL1DS PL1BS	BQ8080DS BQ8080ZS	BUD26DS BUD26WS
5,0 x 5,0	DARK C5050VTD STARWHITE C5050VTW	PL1DS PL1BS	/ /	/ /

Base non compresa nel prezzo | Base not included in the price

## COLOUR RANGE - p.244

### ACRILYC 350GR

- Con Volant / with Volant
- Senza Volant / without Volant
- A1S
- A1N
- T2S T3S
- T6N T7N
- T8N T9N S1N

## VERIFICA LA STABILITÀ - p.236

Check stability - Vérifiez la stabilité - Stabilität prüfen - Compruebe la estabilidad - Controleer de stabiliteit

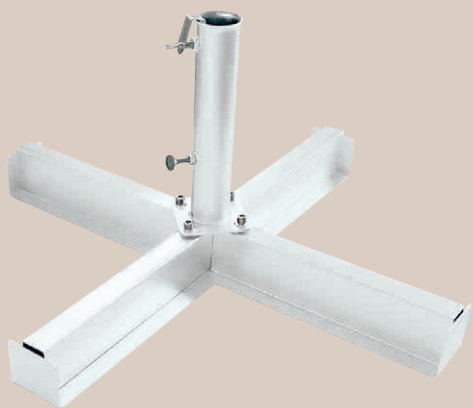

### BQ8080WS **NEW**

- Base a croce metallica zincata. Disponibile con BTT55 e BTT65.  
Tubo incluso. Da abbinare a 8 piastre cemento Art.BC4040
- Zinced cross metal base. Available with BTT55 and BTT65.  
Tube included. To combine with 8 cement plates Art.BC4040
- Verzinkte Stahlplattenstaender. Verfuegbar mit BTT55 und BTT65.  
Huelse inbegriffen. Zum kombinieren mit 8 Betonplatten Art.BC4040
- Pied en acier galvanisé. Disponible avec BTT55 et BTT65.  
Tube incl. À combiner avec 8 dalles ciment Art.BC4040
- Base de metal galvanizado. Disponible con BTT55 y BTT65.  
Tubo incluido. Para combinar con 8 placas de hormigón Art.BC4040
- Metalen basis, verzinkt. Verkrijgbaar met BTT55 en BTT65.  
Tube inbegrepen. Te combineren met 8 betonplaten Art.BC4040



<b>BQ8080WS/BTT55W</b>	850x850 mm	52 mm	55 mm	47-50 mm	8 Kg
<b>BQ8080WS/BTT65W</b>		62 mm	65 mm	55-60 mm	

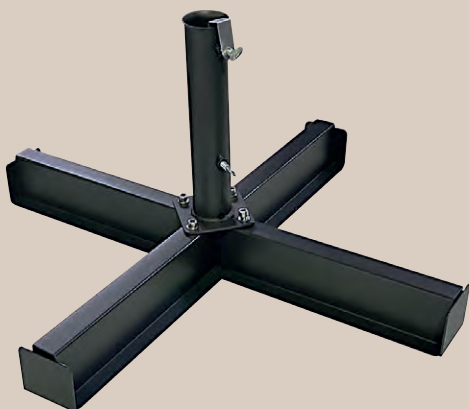

### BQ8080DS **NEW**

- Base a croce metallica colore antracite. Disponibile con BTT55 e BTT65.  
Tubo incluso. Da abbinare a 8 piastre cemento Art.BC4040
- Dark cross metal base. Available with BTT55 and BTT65.  
Tube included. To combine with 8 cement plates Art.BC4040
- Stahlplattenstaender. Anthrazitgrau. Verfuegbar mit BTT55 und BTT65.  
Huelse inbegriffen. Zum kombinieren mit 8 Betonplatten Art.BC4040
- Pied en acier gris. Disponible avec BTT55 et BTT65.  
Tube incl. À combiner avec 8 dalles ciment Art.BC4040
- Base de metal gris. Disponible con BTT55 y BTT65.  
Tubo incluido. Para combinar con 8 placas de hormigón Art.BC4040
- Metalen basis. Houtskoolgrijs. Verkrijgbaar met BTT55 en BTT65.  
Tube inbegrepen. Te combineren met 8 betonplaten Art.BC4040



<b>BQ8080DS/BTT55D</b>	850x850 mm	52 mm	55 mm	47-50 mm	8 Kg
<b>BQ8080DS/BTT65D</b>		62 mm	65 mm	55-60 mm	



# OPTIONAL CROSS METAL BASES

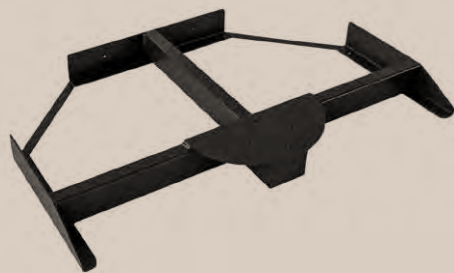

B1DS

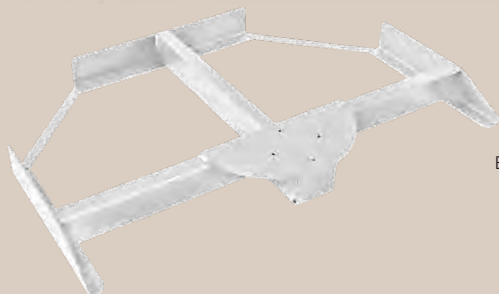

B1BS

## B1DS - B1BS

- Base metallica opzionale per ombrelloni a braccio laterale.
- Optional metal base for side arm parasols.
- Optionaler Metallstaender fuer Ampelschirme.
- Base en métal en option pour parasols à bras deporté.
- Base de metal opcional para sombrillas de brazos laterales.
- Optionele metalen voet voor zijarmparaplu's.



<b>B1DS</b>	1070x710x85 mm	15 Kg
<b>B1BS</b>		



PL1DS

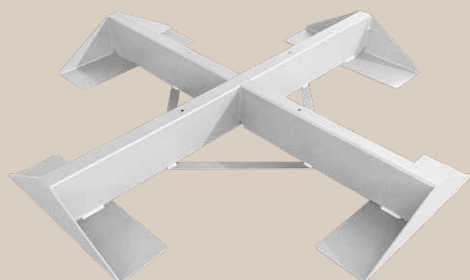

PL1BS

## PL1DS - PL1BS

- Base a croce metallica opzionale per ombrelloni a braccio laterale.
- Optional cross metal base for side arm parasols.
- Optionaler Kreuz-Metallstaender fuer Ampelschirme.
- Base croix en métal en option pour parasols à bras deporté.
- Base cruz de metal opcional para sombrillas de brazos laterales.
- Optionele kruis metalen voet voor zijarmparaplu's.



<b>PL1DS</b>	1090x1090x130 mm	22 Kg
<b>PL1BS</b>		



### Da completare:

To be completed / Ballast ergaenzen /  
A compléter avec ballasts / Completar con losas /  
Aan te vullen met voorschakelapparaten

Pag. 234

con zavorre  
Available ballasts / Verfüegbarer Ballast /  
Ballasts disponibles / Losas disponibles /  
Beschikbare ballasten

Pag. 236

schema di stabilità  
see stability diagram / Stabilitaetsdiagramm /  
diagramme de stabilité / diagrama de estabilidad /  
stabiliteitsdiagram

# CARTER

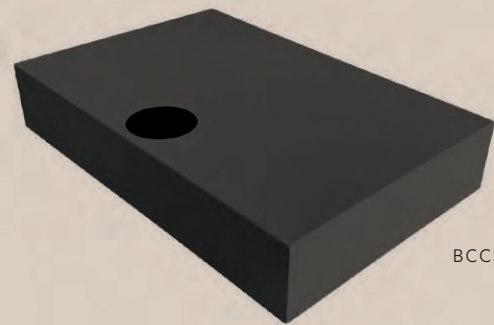

BCCS



BCWS

## BCCS - BCWS

- Carter acciaio zincato e verniciato a polveri. Colori disponibili dark-Starwhite. Compatibile con base B1DS-B1BS.
- Zined and epoxy coated steel carter. Available colors dark-Starwhite. Compatible with base B1DS-B1BS.
- Verzinkter und pulverbeschichteter Stahlcarter. Erhaeltliche Farben dark-Starwhite. Kompatibel mit Staender B1DS-B1BS.
- Carter acier galvanisé et vernis. Couleurs disponibles dark-Starwhite. Compatible avec socle B1DS-B1BS.
- Carter de acero galvanizado y pintado. Colores disponibles dark-Starwhite. Compatible con base B1DS-B1BS.
- Gegalvaniseerd en geepoxeerde metaalcarter. Beschikbare kleuren dark-Starwhite. Compatibel met basis B1DS-B1BS.



KG

BCCS	1100x720x200 mm	18 Kg
BCWS		



## BDCS - BDWS

- Carter acciaio zincato e verniciato a polveri. Colori disponibili dark-Starwhite. Compatibile con base PL1DS-PL1BS.
- Zined and epoxy coated steel carter. Available colors dark-Starwhite. Compatible with base PL1DS-PL1BS.
- Verzinkter und pulverbeschichteter Stahlcarter. Erhaeltliche Farben dark-Starwhite. Kompatibel mit Staender PL1DS-PL1BS.
- Carter acier galvanisé et vernis. Couleurs disponibles dark-Starwhite. Compatible avec socle PL1DS-PL1BS.
- Carter de acero galvanizado y pintado. Colores disponibles dark-Starwhite. Compatible con base PL1DS-PL1BS.
- Gegalvaniseerd en geepoxeerde metaalcarter. Beschikbare kleuren dark-Starwhite. Compatibel met basis PL1DS-PL1BS.



KG

BDCS	1130x1130x120 mm	21 Kg
BDWS		



# OPTIONAL CROSS METAL BASE

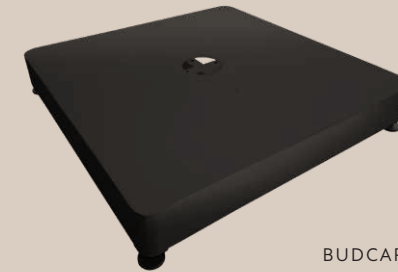

BUDCAR26DS



BUDCAR26WS

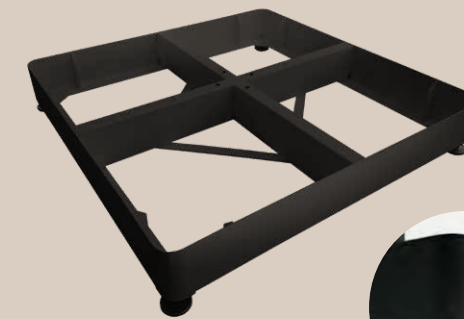

BUD26DS



BUD26WS

## BUDCAR26 NEW

- Carter acciaio zincato e verniciato a polveri. Colori disponibili Dark-Starwhite. Compatibile con base BUD26.
- Zined and epoxy coated steel carter. Available colors Dark-Starwhite. Suitable for base BUD26.
- Verzinkter und pulverbeschichteter Stahlcarter. Erhaeltliche Farben Anthrazitgrau-Weiss. Kombinierbar mit Staender BUD26.
- Carter en acier galvanisé et vernis à poudre. Couleurs disponibles DARK-BLANC. Compatible avec le pied BUD26.
- Carter de acero galvanizado y pintado en polvo. Colores disponibles DARK-BLANCO. Compatible con base BUD26.
- Gegalvaniseerd en gepoedercoate metalen carter. Beschikbare kleuren Dark (antracietgrijs) en Starwhite (matwit). Combineerbaar met parasolvoet BUD26.



KG

BUDCAR26DS	928x928x2 mm	13 Kg
BUDCAR26WS		



## BUD26 NEW

- Base a croce metallica opzionale per ombrellone a braccio da completare con 12 BC4040, non comprese. Compatibile con kit ruote B8080R.
- Optional cross metal base for cantilever parasols to be completed with 12 BC4040, not included. Compatible with wheel kit B8080R.
- Alternativer Stahlplattenstaender fuer Seitenarmschirme zum kombinieren mit 12 BC4040, nicht inbegriffen. Kompatibel mit Rollen B8080R.
- Pied en acier optionnelle pour parasols bras deporté à combiner avec 12 BC4040, non inclus. Compatible avec kit roulettes B8080R.
- Base de metal opcional para sombrillas brazo lateral para completar con 12 BC4040, no incluido. Compatible con juego de ruedas B8080R.
- Optionele metalen basis voor arm parasol uit te voeren met 12 BC4040, niet inbegrepen. Compatibel met wielkit B8080R.



KG

BUD26DS	924x924x125 mm	21 Kg
BUD26WS		



## B8080R

- Kit ruote alta resistenza girevoli e frenanti.
- High resistance rotating and braking wheels kit.
- Hochleistungs-Dreh- und Bremsraeder-Set.
- Kit roues rotatives et freinage haute résistance.
- Kit ruedas giratorias y frenos de alta resistenci.
- Kit met hoge weerstand draaiende en remwielen.



# BALLAST



			<b>KG</b>
<b>BC4040</b>	400x400 mm		14 Kg
<b>BC5050</b>	500x500 mm		20 Kg

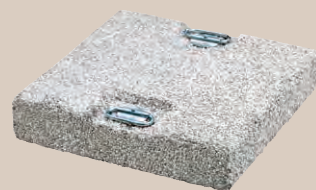

			<b>KG</b>
<b>BC5151</b>	500x500 mm		60 kg



			<b>KG</b>
<b>BC5151G</b>	500x500 mm		60 kg



			<b>H</b>	<b>KG</b>
<b>BV5050G</b>	500x500 mm	270 mm		80 kg



			<b>H</b>	<b>KG</b>
<b>BV5050B</b>	500x500 mm	270 mm		80 kg

## BC4040 - BC5050

- Piastra in cemento e graniglia. Spessore 4 cm.
- Cement grit slab. Thickness 4 cm.
- Kiesbetonplatte. Dicke 4 cm.
- Dalles ciment et grès. Epaisseur 4 cm.
- Planchas de hormigón y de grava. De espesor 4 cm.
- Gewassen grindtegel. Dikte 4 cm.

## BC5151

- Piastra in cemento e graniglia bianca con maniglie. Spessore 11cm. Per ombrelloni a braccio.
- White cement grit slab with handles. Thickness 11cm. For cantilever parasols.
- Weisse Kiesbetonplatte mit Handgriffen. Dicke 11cm. Fuer Pendelschirme.
- Dalles ciment et grès avec poignées blanc. Epaisseur 11cm. Pour parasols avec bras deporté
- Placas blancas de hormigón y arena con asas. De espesor 11 cm. Para parasoles con voladizo.
- Wit gewassen grindtegel met handgrepen. Dikte 11 cm. Geschikt voor vrijhangende parasols.

## BC5151G

- Piastra in cemento grigio con maniglie. Spessore 11cm. Per ombrelloni a braccio.
- Concrete grey cement slab with handles. Thickness 11cm. For cantilever parasols.
- Grauer Betonplatte mit Handgriffen. Dicke 11cm. Fuer Pendelschirme.
- Dalles ciment couleur gris avec poignées. Epaisseur 11cm. Pour parasols avec bras deporté.
- Base de cemento gris con asas. De espesor 11 cm. Para parasoles con voladizo.
- Betontegel grijs met handgrepen. Dikte 11 cm. Geschikt voor vrijhangende parasols.

## BV5050G

- Vaso in cemento grigio con maniglie. Spessore 11cm. Per ombrelloni a braccio.
- Concrete grey cement pot with handles. Thickness 11cm. For cantilever parasols.
- Grauer Betontopf mit Handgriffen. Dicke 11cm. Fuer Pendelschirme.
- Vase ciment couleur gris avec poignées. Epaisseur 11cm. Pour parasols avec bras deporté.
- Maceta de cemento gris con asas. De espesor 11 cm. Para parasoles con voladizo.
- Plantenschaal grijs met handgrepen. Dikte 11 cm. Geschikt voor vrijhangende parasols.

## BV5050B

- Vaso in cemento bianco con maniglie. Spessore 11cm. Per ombrelloni a braccio.
- Concrete white cement pot with handles. Thickness 11cm. For cantilever parasols.
- Weisser Betontopf mit Handgriffen. Dicke 11cm. Fuer Pendelschirme.
- Vase ciment couleur blanc avec poignées. Epaisseur 11cm. Pour parasols avec bras deporté.
- Maceta de cerámica con asas de hormigón. De espesor 11 cm. Para parasoles con voladizo.
- Plantenschaal beton met handgrepen. Dikte 11 cm. Geschikt voor vrijhangende parasols.

# GROUND FIXING



## CP3030DS - CP3030BS

- Contropiastra acciaio colore bianco Starwhite o Antracite per fissaggio a terra. 30x30 cm.
- Small metal plate for ground fixing. Starwhite and Anthracite color. 30x30 cm.
- Verzinkte Stahlplatte fuer Bodenbefestigung. Farbe Weiss oder Anthrazitgrau. 30x30 cm.
- Contreplaque en acier galvanisé et vernis BLANC ou DARK pour fixation au sol. Dimensions : 30 x 30 cm.
- Contraplaca de acero galvanizado y pintado color BLANCO o DARK para fijación al suelo. Tamaño: 30x30 cm.
- Metalen zinkplaat in kleuren Dark (antracietgrijs) en Starwhite (matwit) voor grondbevestiging. 30x30 cm.

			<b>KG</b>
<b>CP3030DS</b>	300x300 mm		7 Kg
<b>CP3030BS</b>	300x300 mm		7 Kg

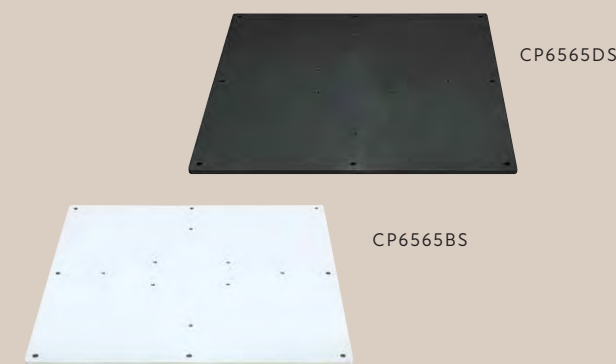

## CP6565DS - CP6565BS

- Contropiastra acciaio colore bianco Starwhite o Antracite per fissaggio a terra. 65x65 cm.
- Metal plate for ground fixing. Starwhite and Anthracite color. 65x65 cm.
- Verzinkte Stahlplatte fuer Bodenbefestigung. Farbe Weiss oder Anthrazitgrau 65x65 cm.
- Contreplaque en acier galvanisé et vernis BLANC ou DARK pour fixation au sol. Dimensions : 65 x 65 cm.
- Contraplaca de acero galvanizado y pintado color BLANCO o DARK para fijación al suelo. Tamaño: 65x65 cm.
- Metalen zinkplaat in kleuren Dark (antracietgrijs) en Starwhite (matwit) voor grondbevestiging. 65x65 cm.

			<b>KG</b>
<b>CP6565DS</b>	650x650 mm		30 kg
<b>CP6565BS</b>	650x650 mm		30 kg

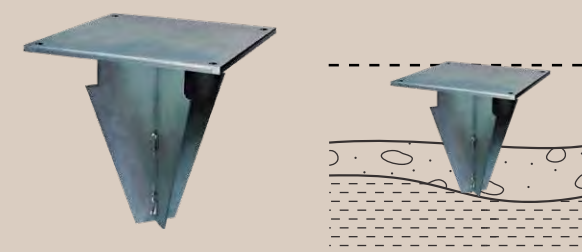

## BTBS

- Supporto da interrare. acciaio zincato.
- In ground anchor. zined steel.
- Bodenanker. Verzinktes stahl.
- Base pour ancrage au sol. acier galvanisé.
- Base para fijación a tierra. acero galvanizado.
- Grondanker. gegalvaniseerd staal.

			<b>KG</b>
<b>BTBS</b>	300x300 mm		10 kg

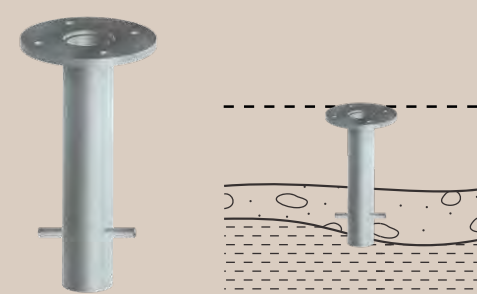

## BTAZS

- Supporto da interrare. Acciaio zincato.
- In ground anchor. Zined steel.
- Bodenanker. Verzinktes Stahl.
- Base pour ancrage au sol. Acier galvanisé.
- Base para fijación a tierra. Acero galvanizado.
- Grondanker. Gegalvaniseerd staal.

			<b>H</b>	<b>KG</b>
<b>BTAZS</b>	Ø 160 mm	350 mm		5 kg

# FABRIC COLLECTION



## FATTORE DI PROTEZIONE SOLARE

Limita il passaggio del calore per più del 70%.

## SOLAR PROTECTION FACTOR

Harmful UV rays and limiting heat circulation



## FATTORE DI PROTEZIONE LUMINOSA

Indica la percentuale di trasmissione della luce

## FACTOR OF SOLAR LIGHT PROTECTION

% of light trasmission



## FATTORE DI PROTEZIONE UPF

Protezione dai raggi U.V. (UPF) dal 85% al 100%

## UPF PROTECTION FACTOR

Harmful UV rays. (UPF) from 85% almost 100%

## SCHEDA TECNICA / DATA SHEET

COMPOSIZIONE / COMPOSITION	CARATTERISTICHE / FINISHING	SOLIDITÀ AL COLORE / COLOR FASTNESS	TRATTAMENTO / TREATMENT	IMPERMEABILITÀ / COLONNA D'ACQUA IMPERMEABILITY / WATER COLUMN
350 gr/m <sup>2</sup> 100% acryl	Inattaccabile da muffe e batteri. Solido alla luce Permeabile all'aria Antimacchia - Resistant to mould and bacteria. Solid to light Air permeable Stain resistant	Grado 7/8 ensio 105-b04 - Grade 7/8 ensio 105-b04	Resine teflon idro-oleorepellenza - Teflon resins water-oil repellent	circa 25 cm - about 25cm

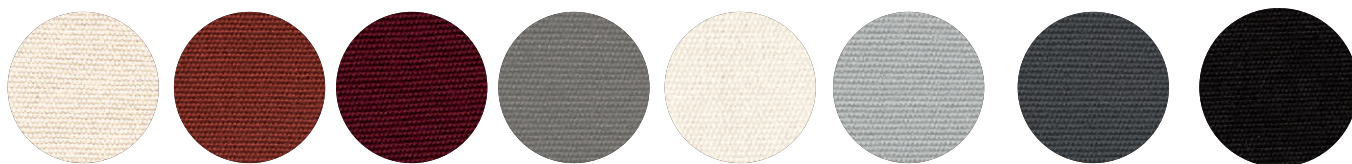

350 GR/M<sup>2</sup>  
ACRYLIC

**A1**  
ECRU  
NATURAL

**T2**  
TERRACOTTA  
ZIEGELROT

**T3**  
BORDEAUX

**T6**  
TAUPE

**T7**  
BIANCO  
WHITE  
WEISS

**T8**  
GRIGIO PERLA  
SILVER GREY  
SILBERGRAU  
GRIS PERLE

**T9**  
ANTRACITE  
ANTHRACIT  
ANTHRAZITGRAU

**S1**  
NERO /BLACK  
SCHWARZ  
NOIRE

	70/80%	> 90%	> 90%	> 90%	70/80%	> 90%	> 90%	> 90%
	20/30%	< 10%	< 10%	< 10%	20/30%	< 10%	< 10%	< 10%
	85/89%	100%	100%	100%	85/89%	100%	100%	100%

I dati forniti, pur essendo frutto di misurazioni scientifiche condotte in laboratori certificati, sono da ritenersi indicativi.  
The above mentioned data are indicative, although provided by scientific measurements performed in certified laboratories.



# MATERIALI E FINITURE

## MATERIALS AND FINISHING

### COMPONENTI E PROFILI ALLUMINIO

#### ALUMINIUM COMPONENTS AND PROFILES



#### Aluminium DARK

Napoli Standard/Braccio  
Leonardo Braccio/Telesc.  
Palladio Braccio  
Torino Braccio  
Galileo Dark  
Galileo Maxi Dark  
Alu Poker / Double Dark  
Wood Poker / Double  
Capri Dark  
Lido Dark  
Revo Dark  
Verona Dark



#### Aluminium STARWHITE

Rimini Standard  
Rimini Braccio  
Pompei Braccio  
Galileo Starwhite  
Galileo Maxi Starwhite  
Alu Poker / Double Starwhite  
Capri Starwhite  
Lido Starwhite  
Revo Starwhite  
Verona Starwhite

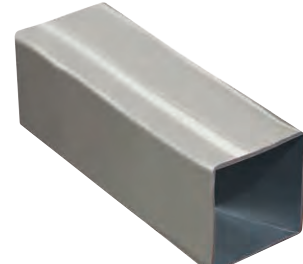

#### ALU TITANIUM

Lido Titanium  
Vela Titanium



#### Aluminium IROKO

Torino Braccio  
Palladio Braccio  
Wood Poker / Double  
Galileo Wood



#### Aluminium DARK

Napoli  
Standard  
Braccio  
Leonardo  
Braccio  
Telescopic  
Galileo Dark  
Galileo Maxi Dark  
Alu Poker  
Double Dark  
Lido Dark  
Revo Dark  
Verona Dark



#### Aluminium STARWHITE

Rimini  
Standard  
Braccio  
Pompei Braccio  
Galileo Starwhite  
Galileo Maxi Starwhite  
LidoStarwhite  
Revo Starwhite  
Verona Starwhite



#### Alu TITANIUM

Lido  
Titanium  
Vela  
Titanium



#### Alu IROKO

Galileo Wood



#### IROKO WOOD

Palladio  
Standard  
Braccio  
Telescopic  
Torino Braccio

## ACCESSORI



Standard

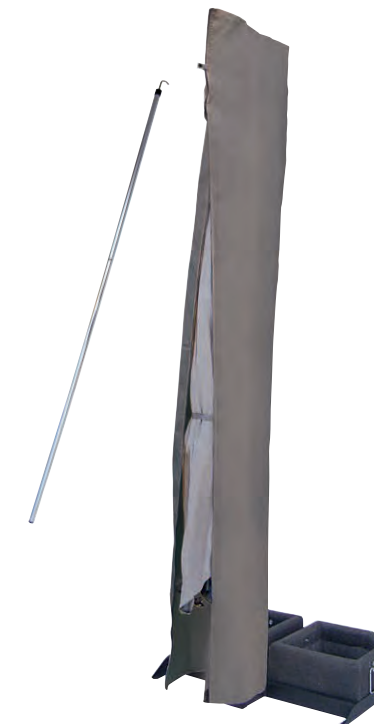

Galileo



Braccio

# KIT LED MAX **NEW** CAPRI E VERONA

Kit completo di luci a LED ad alta luminosità, sviluppato per soddisfare le esigenze del settore professionale.

Il sistema di illuminazione è completamente integrato nelle stecche dell'ombrellone, realizzato direttamente in fase di produzione per garantire la massima pulizia estetica e funzionale: nessun cavo visibile, con barre LED inserite a scomparsa nel profilo della stecca.

Il kit è composto da:

- 4 profili LED IP65 in PMMA satinato per utilizzo esterno, integrati direttamente nelle stecche dell'ombrellone;
- Impianto LED a 12V con luce bianca 3000K;
- Batteria ricaricabile con autonomia minima di 8 ore, completa di contenitore IP65 e caricabatteria;
- Oppure alimentatore elettronico stabilizzato 220Vac – 12Vdc 60W;
- Telecomando IR con funzione dimmer, per la regolazione dell'intensità luminosa;
- Cablaggio completo per utilizzo esterno, integrato all'interno della struttura e totalmente privo di cavi a vista.

## EN

Complete high-brightness LED lighting kit, suitable for a professional and commercial employ. The lighting system is fully integrated into the parasol ribs and installed directly during production to ensure maximum aesthetic and functional cleanliness: no visible cables, with LED profiles seamlessly built into the rib structure.

The kit includes:

- 4 LED profiles IP65 in satin-finish PMMA for outdoor use, integrated directly into the parasol ribs;
- 12V LED system with 3000K warm white light;
- Rechargeable battery with a minimum autonomy of 8 hours, complete with IP65 box and battery charger;
- Or stabilized electronic power supply 220Vac – 12Vdc 60W;
- IR remote control with dimmer function for adjusting the light intensity;
- Complete outdoor wiring, fully integrated inside the structure and completely free of visible cables.

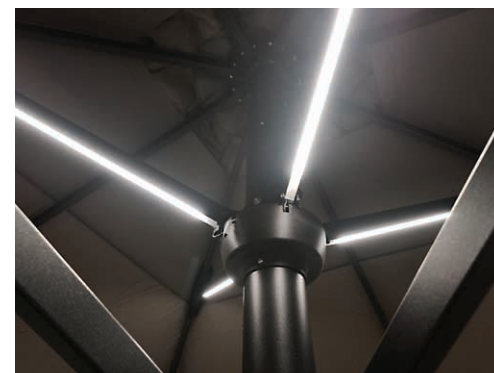
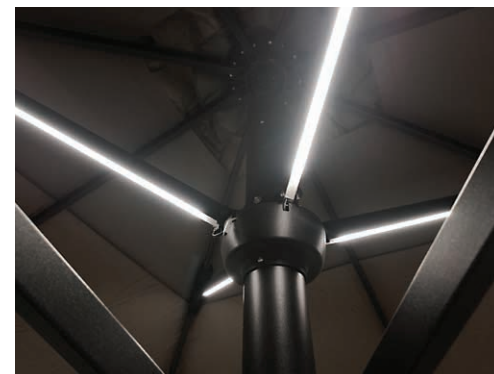
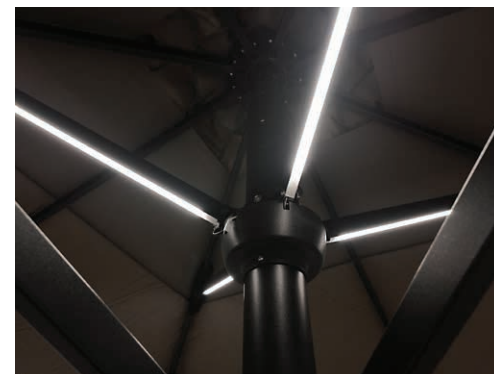
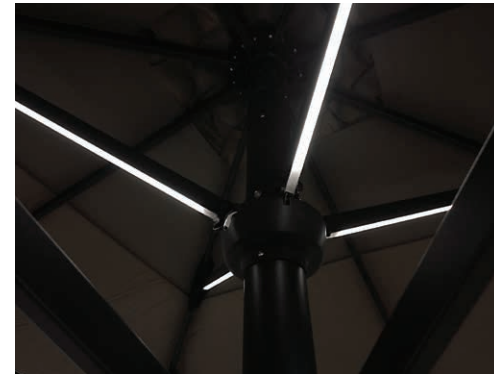

## B: BATTERIA / BATTERY



CARICA BATTERIA  
BATTERY CHARGER



BATTERIA  
BATTERY

## C: CORRENTE / POWER



ALIMENTATORE 220V  
220V POWER SUPPLY

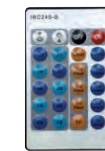

TELECOMANDO IR  
REMOTE CONTROL

Descrizione / Description	Cod.
luce bianca - kit batteria white light - battery kit	KIT.LED.MAX.W.060.B
luce bianca - con collegamento elettrico white light - electrical - connection	KIT.LED.MAX.W.060.C

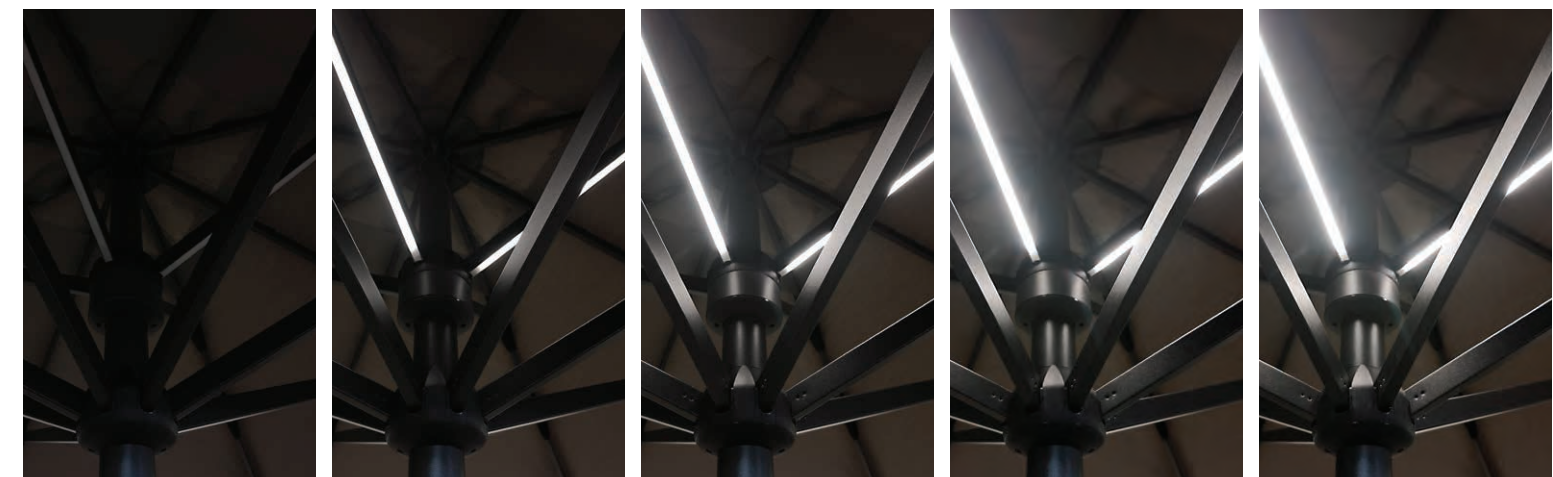



La base e l'eventuale zavorra sono fondamentali per garantire stabilità e sicurezza.

Selezionare l'opzione adeguata al momento dell'ordine.

In caso di fissaggio a terra si esclude il rischio di ribaltamento dell'ombrellone, ma non il cedimento strutturale di alcuni componenti se sottoposti a condizioni atmosferiche incompatibili con l'uso dei nostri prodotti. Queste tabelle sono indicative e prevedono che il pavimento o il terreno di appoggio sia perfettamente piano e regolare.

Gli ombrelloni e i rispettivi componenti delle basi devono essere assemblati correttamente rispettando le istruzioni di montaggio. La stabilità degli ombrelloni può variare nel caso di condizioni atmosferiche particolari. L'utilizzatore finale è responsabile del corretto uso dell'ombrellone. Nessuna rivalsa può essere fatta sul produttore.

## EN

The base and any ballast are essential to ensure stability and safety.

Please select the appropriate option when ordering. In case of ground fixation, the risk of overturning of the parasol is excluded, but not the structural failure of some components, if subjected to atmospheric conditions that are incompatible with the use of our products.

This schedule considers statics calculation and foresees that the floor where the parasol has to be positioned is perfectly flat and regular.

The parasols and components have to be assembled correctly and respecting the assembly instruction. The schedule has to be considered indicative because many variables that depend from the area of employ and position of the parasols are not foreseeable. No rights can be derived from this. The use of a parasol is always on your own responsibility.



## DE

Der Staender und eventueller Ballast sind grundlegend um Stabilitaet und Sicherheit zu gewaehrleisten. Bitte waehlen Sie bei der Bestellung die entsprechende Option aus.

Bei Bodenbefestigung ist das Risiko des Umkippen des Schirms ausgeschlossen, aber nicht das strukturelle Versagen einiger Bestandteile, wenn es atmosphärischen Bedingungen ausgesetzt wird, die mit der Verwendung unserer Produkte nicht vereinbar sind.

Diese Aufstellung beinhaltet statistische Kalkulationen und sieht vor, dass der Schirm auf einem ebenen und regelmaessigen Boden positioniert wird. Der Schirm und die Bestandteile des Staenders muessen gemass Anbauanleitungen montiert werden. Die Stabilitaet der Schirme kann auf Grund besonderer klimatischen Konditionen aendern. Der Endbenutzer ist fuer die ordnungsgemaesse Verwendung des Schirmes verantwortlich.

## FR

La base et les eventuels poids sont essentiels pour assurer la stabilité et la sécurité. Svpl. sélectionnez l'option appropriée lors de la commande. En cas de fixation au sol, le risque de renversement du parasol est exclu, mais pas la défaillance structurelle de certains composants s'ils sont soumis à des conditions atmosphériques incompatibles avec l'utilisation de nos produits. Ces tableaux sont à titre indicatif et ils prévoient que la surface sur laquelle est implanté le parasol soit parfaitement plane et lisse.

Les parasols et les éléments respectifs des bases doivent être assemblés en respectant scrupuleusement les instructions de montage.

La stabilité des parasols peut varier dans le cas de conditions atmosphériques particulières et dépend du lieu et de l'utilisation propre à chaque utilisateur (le parasol doit être fermé en cas de vent fort et/ou de mauvaises conditions météorologiques).

## ES

La base y las posibles losetas o pesos son fundamentales para garantizar la estabilidad y la seguridad. Seleccione la opción adecuada al realizar el pedido.

En caso de fijación al suelo, se excluye el riesgo de vuelco del parasol, pero no el fallo estructural de algunos componentes si se someten a condiciones atmosféricas incompatibles con el uso de nuestros productos. Estos cuadros son indicativos y requieren que el suelo o el apoyo de tierra sea perfectamente plano y liso.

El parasol y los respectivos componentes de la base deben ser montados correctamente respetando las instrucciones. La estabilidad de los parasoles puede variar según las condiciones atmosféricas.

## NL

Basis en eventuele ballast zijn essentieel om stabiliteit en veiligheid te garanderen. Selecteer alstublieft de juiste optie bij het bestellen. In het geval van bevestiging aan de grond is het risico dat de parasol omvalt uitgesloten, maar niet het structurele falen van sommige onderdelen als ze worden blootgesteld aan atmosferische omstandigheden die onverenigbaar zijn met het gebruik van onze producten.

Dit schema houdt rekening met statische berekeningen en gaat ervan uit dat de vloer waarop de parasol moet worden geplaatst perfect vlak en regelmatig is.

De parasols en onderdelen moeten correct en volgens de montagehandleiding worden gemonteerd. Het schema moet als indicatief worden beschouwd omdat veel variabelen die afhangen van het werkgebied en de positie van de parasols niet te voorzien zijn.

# STABILITY

1

- Peso minimo richiesto
- Minimum required weight
- Erforderliches Mindestgewicht
- Poids minimum requis
- Peso mínimo requerido
- Minimaal vereist gewicht

2

- Stabilità intermedia
- Intermediate stability
- Mittlere Stabilität
- Stabilité intermédiaire
- Estabilidad intermedia
- Gemiddelde stabiliteit

3

- Peso consigliato in condizioni normali
- Recommended weight under normal conditions
- Empfohlenes Gewicht unter normalen Bedingungen
- Poids recommandé dans des conditions normales
- Peso recomendado en condiciones normales
- Aanbevolen gewicht onder normale omstandigheden

4

- Massima stabilità con base
- Maximum stability with base
- Maximale Stabilität mit Staender
- Stabilité maximale avec socle
- Máxima estabilidad con base
- Maximale stabiliteit met voet

5

- Massima stabilità con fissaggio a terra
- Maximum stability with ground fixation
- Maximale Stabilität bei Bodenbefestigung
- Stabilité maximale avec fixation au sol
- Máxima estabilidad con fijación al suelo
- Maximale stabiliteit door bodembevestiging



- In caso di base con ruote, prestare particolare attenzione in caso di vento. Prima di spostare l'ombrellone è necessario chiuderlo.
- In case of base with wheels, be especially careful in windy conditions. Close the parasol before moving it.
- Bei Staender mit Rädern und Wind besonders vorsichtig sein. Der Schirm kann geschlossen bewegt werden.
- Dans le cas d'une base à roues, faites particulièrement attention par temps venteux. Avant de déplacer le parasol, il est nécessaire de le fermer.
- En el caso de una base con ruedas, tenga especial cuidado en condiciones de viento. Antes de mover la sombrilla es necesario cerrarlo.
- Wees vooral voorzichtig met statieven met wielen en wind. De parasol kan in gesloten toestand worden verplaatst.

## BASES

## GROUND FIXING



		BC35MA4	BC55MA4	BC80MA4	BC5151GRA4	BF6565D BF6565W	BF6666D BF6666W	BUD26DS/BUD26WS +N°12 BC4040	BQ8080DS/BQ8080WS +N°8 BC4040	BTC +BTT	CP3030DS/ CP3030BS +BTT	CP6565DS/ CP6565DS +BTT	BTAZS
PALLADIO		1	3	4		3	4	/	/	5	5	/	/
LIDO	Ø 2,5	1	3	4		3	4	/	/	5	5	/	/
REVO		1	3	4		3	4	/	/	5	5	/	/
PALLADIO	Ø 3,0	/	3	4		3	4	/	/	5	5	/	/
NAPOLI RIMINI		/	2	3		2	3	/	4	5	5	/	/
PALLADIO	Ø 3,5	/	2	3		2	3	/	4	5	5	/	/
PALLADIO	Ø 4,0	/	1	2	/	1	2	4	3	5	5	/	/
PALLADIO TEL.	Ø 5,0	/	/	1	/	/	1	3	2	5	5	/	/
VELA LIDO		1	3	4		3	4	/	/	5	5	/	/
PALLADIO	2,0 x 2,0	1	3	4		3	4	/	/	5	5	/	/
LIDO	2,5 x 2,5	/	3	4		3	4	/	/	5	5	/	/
VELA		/	2	3		2	3	5	4	5	5	/	/
PALLADIO		/	2	3		2	3	5	4	5	5	/	/
NAPOLI RIMINI	3,0 x 3,0	/	2	3		2	3	5	4	5	5	/	/
VERONA		/	/	/	/	/	/	5	4	/	5 NO BTT	5 NO BTT	5
PALLADIO		/	1	2	/	1	2	4	3	5	5	/	/
LEONARDO	3,5 x 3,5	/	1	2	/	1	2	4	3	5	5	/	/
VERONA		/	/	/	/	/	/	4	3	/	5 NO BTT	5 NO BTT	5
PALLADIO		/	/	1	/	/	1	4	3	5	5	/	/
LEONARDO PALLADIO TEL.	4,0 x 4,0	/	/	1	/	/	1	4	3	5	5	/	/
VERONA		/	/	/	/	/	/	4	3	/	5 NO BTT	5 NO BTT	5
NAPOLI		/	3	4		3	4	/	/	5	5	/	/
PALLADIO	2,0 x 3,0	/	3	4		3	4	/	/	5	5	/	/
NAPOLI RIMINI		/	1	2	/	1	2	4	3	5	5	/	/
PALLADIO	3,0 x 4,0	/	1	2	/	1	2	4	3	5	5	/	/
LEONARDO PALLADIO TEL.		/	1	2	/	1	2	4	3	5	5	/	/

	B1					PL1			PL1	BUD26				GROUND FIXING				
	B1DS/B1BS	n°2 BC5151 n°6 BC5050	n°4 BC5151 n°12 BC5050	n°2 BV5050	BCCS/BCWS	PL1DS/ PL1BS	n°4 BC5151 n°12 BC5050	n°4 BV5050	BDCS/BDWS	BUD26DS BUD26WS	+n°12 BC4040	B8080R	BUDCAR26DS BUDCA26WS	CP3030DS/ CP3030BS	CP6565DS/ CP6565BS	BTBS	BTAZS	
SIDE POST	Ø 3,5	◆	1	3	2	◆	4	5	◆	◆	3	/	◆	5	5	/	5	
	Ø 4,0	◆	1	3	2	◆	4	5	◆	◆	3	/	◆	5	5	/	5	
	3,0 x 3,0	◆	1	3	2	◆	4	5	◆	◆	3	/	◆	5	5	/	5	
	3,5 x 3,5	◆	1	3	2	+12 BC5050	◆	4	5	+12 BC5050	◆	3	/	+12 BC4040	5	5	/	5
	4,0 x 4,0	◆	/	/	/	◆	2	3	◆	◆	/	/	◆	5	5	/	5	
	2,0 x 3,0 3,0 x 2,0	◆	1	3	2	◆	4	5	◆	◆	3	/	◆	5	5	/	5	
	3,0 x 4,0	◆	1	3	2	◆	4	5	◆	◆	3	/	◆	5	5	/	5	
GALILEO	3,0 x 3,0	◆	1	3	2	◆	4	5	◆	◆	3	⚡	◆	5	5	/	5	
	3,5 x 3,5	◆	/	2	1	+12 BC5050	◆	3	4	◆	2	⚡	+12 BC4040	5	5	/	5	
	4,0 x 4,0	◆	/	/	/	◆	2	3	◆	◆	/	/	◆	5	5	/	5	
	3,0 x 4,0	◆	/	2	1	◆	3	4	◆	◆	2	⚡	◆	5	5	/	5	
CAPRI	4,0 x 4,0	◆	/	/	/	◆	4	5	◆	◆	3	⚡	◆	/	5	5	/	
	5,0 x 5,0	◆	/	/	/	◆	2	4	◆	◆	/	/	◆	/	5	5	/	
	6,0 x 6,0	◆	/	/	/	+12 BC5050	◆	1	3	◆	/	/	+12 BC4040	/	5	5	/	
	3,0 x 4,0	◆	/	/	/	◆	4	5	◆	◆	3	⚡	◆	/	5	5	/	
	4,0 x 5,0	◆	/	/	/	◆	2	4	◆	◆	/	/	◆	/	5	5	/	
	5,0 x 6,0	◆	/	/	/	◆	1	3	◆	◆	/	/	◆	/	5	5	/	
VERONA	5,0 x 5,0	◆	/	/	+12 BC5050	◆	2	4	+12 BC5050	◆	/	/	+12 BC4040	5	5	/	5	
DOUBLE	3,0 x 6,0	◆	/	/	/	+12 BC5050	◆	2	4	+12 BC5050	◆	/	/	/	5	5	/	
	3,5 x 7,0	◆	/	/	/	◆	1	3	◆	◆	/	/	◆	/	5	5	/	
POKER	6,0 x 6,0	◆	/	/	/	+12 BC5050	◆	2	3	+12 BC5050	◆	/	/	/	5	5	/	
	7,0 x 7,0	◆	/	/	/	◆	2	3	◆	◆	/	/	+12 BC4040	/	5	5	/	

# USO E MANUTENZIONE

## INDICAZIONI

- Prima dell'uso, conservare e leggere attentamente i manuali e le istruzioni di montaggio che si trovano all'interno della confezione.
- La base deve essere zavorrata. Un peso insufficiente compromette seriamente la stabilità dell'ombrellone.
- Rimuovere sempre la manovella quando non in uso e tenerla fuori dalla portata dei bambini.
- Per evitare danni o lesioni personali, l'ombrellone deve essere chiuso e in alcune condizioni atmosferiche avverse potrebbe essere necessario rimuovere il prodotto e stoccarlo in luogo protetto. Ricorda sempre che l'ombrellone non è una costruzione fissa. La ditta Scolaro non può essere ritenuta responsabile per danni alla merce fornita, o lesioni derivanti da un uso improprio e dal mancato rispetto delle istruzioni e delle linee guida fornite.

## IMPIEGO DEL PRODOTTO

Prima di iniziare ad aprire l'ombrellone, assicurarsi che il tessuto non sia rimasto impigliato nelle stecche interne. Per aprire o chiudere l'ombrellone ruotare la maniglia (dove presente) nel senso indicato dalle frecce e dalla scritta "Apri" o "Chiudi". Un funzionamento errato potrebbe strappare la corda o danneggiare il meccanismo. Non forzare mai le corde o maniglie. Se si bloccano, controlla perché è successo ed elimina la possibile causa.

Parti in legno: applicare un impregnante per legno a base di cera almeno una volta all'anno prima della stagione invernale. Chiudere l'ombrellone quando le condizioni meteorologicxhe non sono adatte, ad es. forte vento o pioggia battente.

Gli ombrelloni Scolaro possono essere abbinati a basi speciali sviluppate per il fissaggio a terra. Qualora si decida di posizionare un ombrellone Scolaro utilizzando solo zavorra, ne viene certificata l'idoneità all'utilizzo in condizioni di vento moderato. Nella tabella specifica sono indicate le zavorre minime. Il Cliente è l'unico responsabile dell'installazione e della gestione dell'ombrellone.

## ACCIAIO INOSSIDABILE

### Attenzione:

1. NON UTILIZZARE I SEGUENTI PRODOTTI su parti in acciaio inossidabile: Candeggina a base di cloro o detersivi contenenti candeggina (possono corrodere l'acciaio inossidabile). Acido cloridrico o prodotti contenenti cloruri (possono corrodere l'acciaio inossidabile).
2. Il sale, il calcare o gli acidi (bevande e alimenti) possono scolorire le parti in acciaio inossidabile se non pulite tempestivamente.
3. I prodotti o le parti in acciaio inossidabile utilizzati in prossimità del mare o per la decorazione interna delle piscine richiedono una pulizia più frequente per rimuovere i cloriti depositati e per prevenire la corrosione e il deterioramento chimico delle superfici esterne.
4. Macchie o ruggine rilevate sulle superfici in acciaio inossidabile devono essere pulite tempestivamente.
5. Le macchie non rimosse per lunghi periodi possono diventare permanenti.
6. La ruggine può causare reazioni chimiche o corrodere l'acciaio inossidabile.

### Per rimuovere macchie o ruggine:

- Applicare un detersivo o lucidante specifico non abrasivo per acciaio inox.
- Sciacquare accuratamente con acqua pulita.
- Infine asciugare bene per evitare che si formino striature, sfregamento nel senso delle fibre.

## METALLI VERNICIATI: FERRO E ALLUMINIO

Per una lunga durata dell'ombrellone si consiglia di riporlo in ambienti asciutti, durante il periodo invernale e quando non utilizzato. Si consiglia inoltre di controllare una volta a stagione, soprattutto dopo un lungo periodo di inattività, il corretto funzionamento di tutti i componenti. La nostra garanzia non copre alcun tipo di graffio o abrasione alla finitura causata dal contatto con altri arredi o dalla conseguente corrosione.

L'impiego in ambienti marini può portare all'accumulo di sali e cloruri sulla verniciatura a polvere. La mancata esecuzione di una regolare pulizia con acqua dolce può causare la formazione di bolle, ossidazioni, scolorimento e invalidare la garanzia. Per la pulizia delle superfici in metallo verniciato utilizzare acqua fredda e detersivi liquidi non abrasivi o aggressivi. Applicare con un panno morbido. Nel caso di superfici molto sporche e/o invecchiate, dopo la pulizia, si consiglia di trattarle con paraffina liquida. In caso di macchie causate da depositi di calcare su vernici di struttura grossolana (es. ferro antico e marrone d'india) pulirle con uno straccio e una soluzione di aceto di vino bianco diluito in acqua fredda.

## LEGNO: IROKO

Legno tradizionale impiegato per l'arredo esterno e l'industria nautica. L'Iroko è un legno duro ad alto contenuto di olio, adatto per uso esterno. Estremamente duraturo. È praticamente inalterabile alla ripetuta esposizione agli agenti atmosferici. Anche se trattato, la superficie assume una patina grigio argento che è la naturale protezione dall'interno del legno, considerato parte essenziale del fascino dell'Iroko. La naturale tendenza del legno ad ingrigire o perdere la brillantezza della vernice può essere prevenuta nelle prime fasi di vita del prodotto. L'ombrellone può essere ripristinato mediante un nuovo trattamento con adeguato prodotti facilmente reperibili nei negozi specializzati. È necessario applicare una soluzione di acqua e olio incolore, a superfici esposte con un panno. L'olio deve essere molto diluito. Le macchie superficiali possono essere rimosse intervenendo per tempo, prima che il legno possa assorbirle completamente. Carteggiare delicatamente la superficie in questione e poi lucidare con un panno ruvido.

## TESSUTI SINTETICI: ACRILICO E POLIESTERE

Il tessuto è impermeabile e trattato antimuffa per respingere l'acqua, le macchie e garantire la traspirazione. Si prega di seguire le nostre istruzioni di manutenzione per garantire la lunga durata del tessuto:

- Rimuovere spesso depositi di polvere, macchie e qualsiasi tipo di sporco per evitare tracce dopo la pulizia.
- È molto importante chiudere l'ombrellone solo quando è perfettamente asciutto. Durante l'inverno e quando l'ombrellone non viene utilizzato, deve essere conservato in un ambiente asciutto. Evitare il contatto prolungato con sostanze oleose e/o coloranti che potrebbero essere assorbite dal materiale di rivestimento in PVC e causare macchie permanenti, oltre a danneggiare la struttura del filo. Non utilizzare solventi o detersivi a base di solventi (evitare l'acetone). Usare acqua e detersivi liquidi non abrasivi, incolori, a PH neutro. Lasciare agire il detersivo per qualche minuto. Risciacquare bene con acqua non più calda di 30°C.

## COMPONENTI

I componenti in acciaio, la viteria e gli accessori sono trattati antiruggine. Comunque per una lunga durata dell'ombrellone, durante l'inverno e quando non viene utilizzato, l'ombrellone deve essere conservato in ambiente asciutto. Durante ogni stagione è necessario verificare la funzionalità di tutti i componenti, soprattutto dopo un lungo periodo di inattività. La ditta Scolaro è a vostra disposizione per assistenza tecnica.

## CATAFORESI

Il trattamento di cataforesi è un processo di verniciatura a immersione che garantisce una protezione uniforme e duratura di tutte le superfici metalliche, anche nelle zone meno accessibili. Durante il procedimento, il componente viene immerso in un bagno contenente particelle di vernice caricate elettricamente: grazie all'azione elettrochimica, queste aderiscono in modo omogeneo al metallo, creando uno strato protettivo continuo, compatto e resistente alla corrosione. Questo trattamento rappresenta uno standard qualitativo di alto livello, assicurando maggiore durabilità, estetica costante nel tempo e protezione contro agenti atmosferici e salsedine: ideale per componenti metallici destinati ad ambienti esterni, assicurando durata e affidabilità nel tempo.

# GARANZIA

Gli ombrelloni Scolaro sono progettati per durare molti anni esposti all'uso esterno.

Come per molti articoli, l'attenzione nell'uso e nella manutenzione e il rispetto delle istruzioni contenute in queste pagine, permette una vita media ancora più lunga del prodotto e la possibilità di godere di un prodotto ancora più efficiente ed esteticamente gradevole.

I prodotti Scolaro sono garantiti 2 anni.

Se si rispettano le indicazioni e i consigli, la garanzia può essere estesa come segue:

**LA GARANZIA COPRE SOLO I DIFETTI DI FABBRICAZIONE DI INTEGRITÀ STRUTTURALE. LA GARANZIA NON COPRE DANNI CAUSATI DA AZIONI MECCANICHE, FORZA NATURALE E ATTI DOLOSI.**

### 5 anni di garanzia sui componenti in alluminio e acciaio inox.

**Inclusa verniciatura e viti.**

- Difetti strutturali non derivanti da uso improprio o mancata manutenzione.
- Corrosione invasiva non prodotta da graffi o abrasioni da utilizzo non asportabile mediante normale pulizia e manutenzione.

### 5 anni di garanzia sui colori e sul trattamento dei tessuti (resistenza).

- La sostituzione della coperta durante il periodo di garanzia è prevista solo in caso di scolorimento prima della fine del periodo di garanzia. Gli utenti devono conservare correttamente i tessuti, affinché la garanzia sia effettiva. Una corretta manutenzione implica una pulizia regolare.
- La garanzia non copre i danni da contatto con oggetti estranei, abrasioni causate dal vento, uso improprio o abuso (strappi, bruciature e fori). L'uso intensivo in ambiente aggressivo (mare e piscina), richiede un regolare risciacquo del tessuto con acqua dolce per prevenire ed evitare l'accumulo di residui salini e clorurati.

### 2 anni di garanzia su tutti gli elementi metallici e in acciaio in genere

**1 anno di garanzia sui meccanismi di apertura con manovella**, previo uso corretto e rispettoso delle istruzioni fornite.

**2 anni di garanzia in genere per le finiture e altri materiali non specificatamente menzionati e scritti sopra**, comprese le basi in cemento e le zavorre

**1 anno di garanzia sui kit luci LED e sui componenti elettrici in general.**

## LA GARANZIA NON SI APPLICA:

- Se il prodotto non è stato assemblato secondo le istruzioni fornite;
- in caso di uso improprio del prodotto o non conforme alla normale destinazione d'uso del bene;
- in caso di mancato rispetto delle istruzioni per l'uso e la manutenzione indicate nel materiale informativo fornito con il prodotto;
- in caso di stoccaggio in condizioni ambientali non idonee al prodotto;
- in caso di modifica o manomissione del prodotto;
- se il prodotto è stato assemblato o combinato con componenti e prodotti non forniti da Scolaro.

Per usufruire della garanzia è necessario esibire l'articolo difettoso o inviare le foto, unitamente alla fattura o scontrino fiscale.

La garanzia comprende la fornitura di parti di ricambio o la sostituzione del prodotto se necessario. La garanzia non comprende la riparazione in loco o il rimborso delle spese sostenute per il mancato utilizzo del prodotto.

In caso di vizio accertato da Scolaro, si riserva il diritto - a propria discrezione - di sostituire il prodotto con uno uguale o equivalente per caratteristiche essenziali o di rimborsare al cliente solo l'importo pagato per il prodotto. Nessuna ulteriore spesa o danno potranno essere richiesti a Scolaro.

Scolaro non sarà responsabile per eventuali danni a cose o persone derivanti da un uso improprio del prodotto.

Politica di servizio e riparazioni

Anche in caso di danneggiamenti e rotture, Scolaro ha sempre adottato un'attenta e puntuale politica di assistenza post vendita.

In qualunque caso di danneggiamento o necessità, consigliamo di contattare la nostra azienda per valutare la possibilità di riparare e recuperare il prodotto, nonché per ottenere assistenza per eseguire l'intervento.

*La corrispondenza ad alti standard qualitativi e funzionali dei materiali impiegati costituisce la garanzia principale della robustezza e resistenza nel tempo dei prodotti Scolaro. Un comportamento rispettoso di norme di manutenzione ed uso, come specificato di seguito, assicura una durata ancora maggiore.*

Le informazioni contenute in questo catalogo o in altri stampati pubblicitari della ditta Scolaro, quali caratteristiche tecniche dei prodotti o dei componenti, dimensioni, schemi di montaggio, colori, ecc., hanno valore meramente indicativo, in ragione delle specifiche tecniche e della evoluzione tecnologica dei prodotti aziendali. Al fine di migliorare la qualità del prodotto, la ditta si riserva il diritto di modificare lo stesso senza alcun preavviso e anche dopo l'accettazione dell'ordine. L'azienda si riserva di apportare modifiche parziali o totali ai prodotti senza preavviso declinando ogni responsabilità su eventuali dati inesatti. Eventuali lievi variazioni di tonalità dei colori e delle finiture rientrano nelle normali caratteristiche dei materiali impiegati. Tutte le differenze sopraindicate non sono tali da modificare significativamente i prodotti stessi e non costituiscono motivo di reso o sostituzione della merce o di contestazione.

# USE AND MAINTENANCE

## DIRECTIONS

- Before use, directions and assembling instructions, which are inside the package, have to be kept and read carefully.
- The base has to be ballasted. An insufficient weight will seriously compromise the stability of the parasol.
- Always remove crank when not in use and keep out of reach of children.
- To avoid damage or personal injury, parasol must be closed and in some extreme weather conditions it may be necessary to remove the product and store it in a protected place. Remember always that the parasol is not a fixed construction. The company Scolari cannot be held responsible for damages to goods supplied, or injury resulting from improper use and failure to follow instruction and guidelines given on.

## PRODUCT EMPLOY

Before starting to open the parasol, make sure that the fabric has not got caught in the internal ribs. To open or close the parasol, turn the handle (where available) in the direction indicated by the arrows and the words "Open" or "Close". Incorrect operation could tear the string or damage the mechanism. Never force the ropes or handles. If they get stuck, check why this has happened and eliminate the possible cause. Wooden parts: apply a wax-based wood-stainer at least once a year before the winter season. Close the parasol when the weather conditions are unsuitable, strong wind or heavy rain.

Scolari parasols can be combined with special bases developed for the ground fixing. If it is decided to position a Scolari parasol using ballast only, their suitability for use in conditions of moderate wind is certified. In the specific table the minimum ballast weights are indicated. The Customer is the sole party responsible for installing and managing the parasol.

## STAINLESS STEEL

### Attention:

1. DO NOT USE THE FOLLOWING PRODUCTS on any parts made of stainless steel: Chlorine bleach or detergents containing bleach (they can corrode stainless steel). Hydrochloric acid or products containing chlorides (they can corrode stainless steel).
2. Salt, limestone or acids (drinks and food) may discolour parts made of stainless steel if not cleaned promptly.
3. Products or parts made of stainless steel used near the seaside or for the interior decoration of swimming pools require more frequent cleaning in order to remove chlorites deposited on them and to prevent corrosion and chemical deterioration of the external surfaces.
4. Stains or rust noted on stainless steel surfaces must be cleaned promptly.
5. Stains left in place for long periods may become permanent.
6. Rust may cause chemical reactions or corrode stainless steel.

### To remove stains or rust:

- Apply a specific non-abrasive detergent or polish for stainless steel.
- Rinse thoroughly with clean water.
- Lastly, dry thoroughly in order to prevent streaks from occurring, rubbing in the sense of the fibres.

## VARNISHED METALS: IRON AND ALUMINIUM

For a long lasting of the parasol we recommend to store it in dry environments, during the winter and when not in use. It's also recommended to check once a season, especially after a long period of inactivity, the proper functioning of all components. Our warranty does not cover any type of scratches or abrasions to finish caused from the contact with other furniture or any resulting corrosion.

The employ in marine environments can lead to the accumulation of salt and chlorides on the powder coating. Failure to perform regular cleaning with fresh water can cause blisters, oxidation, discoloration and invalidates the warranty.

To clean surfaces in varnished metals, use cold water and non abrasive or aggressive liquid detergents.

Apply with a soft cloth. In the case of very dirty and/or aged surfaces, after cleaning, it is advisable to treat them with liquid paraffin. In the event of stains caused by lime deposits on varnishes of coarse structure (eg. antique iron and indian brown) clean them with a cloth and a solution of white wine vinegar diluted in cold water.

## WOOD: IROKO

Traditional wood employed for outdoor furniture and the marine industry. Iroko is a hardwood with a high oil content, suitable for external use. Extremely long-lasting. It is practically unalterable to repeated exposure to atmospheric factors. Even if treated, the surface takes a silver-grey coating which is the natural protection from inside the wood, considered an essential part of Iroko's charm.

The natural tendency of wood to turn gray or lose the brightness of the paint can be prevented in the early stages of the product life. The parasol can be restored by a new treatment with proper products easy to find in specialized shops. It's necessary to apply a solution of water and colourless oil, to exposed surfaces with a cloth. The oil must be highly diluted. Superficial stains can be removed by intervening in time, before the wood can fully absorb them. Gently sand the surface in question and then polish with a rough cloth.

## SYNTHETIC FABRICS: ACRYL AND POLYESTER

The fabric is waterproof and anti mould treated to reject water, spots and grant transpiration. Please follow our maintenance instruction to grant the long lasting of the fabric:

- Remove often dust deposits, spots and any type of dirt in order to avoid trails after cleaning.
- It's very important to close the parasol only when it is perfectly dry. During the winter and when the parasol is not employed, it has to be stored in dry environment. Avoid prolonged contact with oily substances and/or dyes that could be absorbed by the covering material in PVC and cause permanent stains, in addition to damaging the structure of the thread. Do not use solvents or solvent-based detergents (avoid acetone). Use water and non-abrasive, colourless liquid detergents with a neutral PH. Let the detergent act for a few minutes. Rinse well with water no warmer than 30°C.

## COMPONENTS

The steel components, screws and accessories are anti rust treated. Anyway for a long lasting of the parasol, during the winter and when the it is not employed, the parasol has to be stored in dry environment. During every season it is necessary to check the functionality of all components, especially after a long period of non-employ. The company Scolari is at your disposal for technical assistance.

## CATAPHORESIS

Cataphoresis treatment is an immersion painting process that guarantees uniform and long-lasting protection of all metal surfaces, even in the least accessible areas. During the process, the component is immersed in a bath containing electrically charged paint particles: thanks to the electrochemical action, these adhere homogeneously to the metal, creating a continuous, compact and corrosion-resistant protective layer.

This treatment represents a high level quality standard, ensuring greater durability, constant aesthetics over time and protection against atmospheric agents and salt: ideal for metal components intended for outdoor environments, ensuring durability and reliability over time.

# WARRANTY

Scolari parasols are designed to last for many years exposed to outdoor use.

As with many items, attention in use and maintenance and following the instructions contained in these pages, allows an even longer average life of the product and the possibility of enjoying an even more efficient and aesthetically pleasing product.

Scolari's products are guaranteed for 2 years. If you comply with the indications and advices, the warranty can be extended as follows:

**THE WARRANTY COVERS ONLY MANUFACTURING DEFECTS OF STRUCTURAL INTEGRITY. THE WARRANTY DOES NOT COVER DAMAGES CAUSED BY MECHANICAL ACTIONS, FORCE OF NATURE AND MALICIOUS ACTS.**

**5 years warranty on aluminum and stainless steel components. Including painting and screws.**

- Structural faults not resulting from improper use or lack maintenance.
- Invasive corrosion not produced by scratches or abrasions from use not removable through normal cleaning and maintenance.

**5 year warranty on colors and treatment of fabrics (strength).**

- The replacement of the canopy during the warranty period is foreseen only if it loses its color before the end of the warranty period. Users must properly maintain fabrics for the warranty to be effective. Proper maintenance implies regular cleaning.
- The warranty does not cover damage from contact with foreign objects, wind-driven abrasions, misuse or abuse (tears, burns and holes). The intensive employ in an aggressive environment (seaside and pool use), requires a regular rinse of the fabric with fresh water in order to prevent and avoid the build-up of salt and chloride residues.

**2 years warranty on all metal and steel elements in general**

**1 year warranty on the opening mechanisms with crank** subject to correct and respectful use according to the instruction given.

**2 years warranty in general for finishes and other materials not specifically mentioned and written above,** including concrete bases and ballasts.

**1 year warranty on LED light kits and electrical components in general.**

**THE WARRANTY DOES NOT APPLY:**

- If the product has not been assembled according to the instructions provided;
- in the event of improper use of the product or use that does not conform to normal intended use of the property;
- in case of non-compliance with the instructions for use and maintenance indicated in the information material supplied with the product;
- in case of storage in environmental conditions that are not suitable for the product;
- in case of modification or tampering with the product;
- if the product has been assembled or combined with components and products not provided by Scolari.

To take advantage of the warranty the faulty item must be shown or pictures must be forwarded, together with the invoice or receipt.

The warranty includes the supply of spare parts or the replacement of the product if necessary.

The warranty does not include the repair on-site or the refund of costs incurred for non-use of the product. In case of defect confirmed by Scolari, it reserves the right - at its own discretion - to replace the product with an equal or equivalent one for essential characteristics or to refund only the amount paid for the product to the customer.

No further expenses or damages can be requested from Scolari. Scolari will not be liable for any damage to properties or individuals deriving from an improper use of the product.

Service and repairs policy

Even in the event of damage and breakage, Scolari has always adopted a careful and punctual after-sales assistance policy.

In any case of damage or need, we recommend contacting our company to evaluate the possibility of repairing and recovering the product, as well as to get assistance in carrying out the intervention.

*The connection between the high qualitative and functional standards of the materials used, constitutes the main guarantee of the sturdiness and the resistance of the company's products over time. Respecting the rules of maintenance and use, specified as follows, will ensure the success of these objects, which were devised with Scolari quality, to last a long time.*

The information contained in this brochures or other Scolari's advertisements prints, such as product specifications or components, dimensions, assembling instruction, colours, etc., are purely indicative, because of the technical specifications and the technological evolution of the company's products. In order to improve the quality of the product, the company reserves the right to change the same without prior notice and even after acceptance of the order. The company reserves the right to make partial or complete changes to the products without prior notice and declines any responsibility for inaccurate data. Any colour differences and changes of finishing have to be considered normal characteristics of the materials used. These differences do not significantly change the products and aren't reason for return or replacement of the goods or dispute.

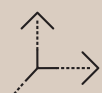

- Dimensione (metri)
- Dimensions (meters)
- Masse (Meter)
- Dimensions (metrès)
- Dimensiones ( en metros)
- Afmeting in (meters)



- Stecche
- Ribs
- Streben
- Baleines
- Brazos superiores
- Baleinen



- Blocco antivento
- Wind stop
- Windstop
- Block antivent
- Freno para el viento
- Windstop



- Sistema retrattile
- Retractable system
- Einziehbares System
- Système retractile
- Sistema retráctil
- Inklapbaar systeem



- Lunghezza
- Length
- Laenge
- Altura
- Longitud



- Set canaline
- Raingutter set
- Regerinnen
- Set gouttières
- Canalizador Lluvias
- Set regengoten



- Con meccanismo manovella
- With winding mechanism
- Mit Kurbelmechanismus
- Avec mécanisme manivelle
- Con manivela
- Met opwindmechanisme



- Ombrellone girevole a 360°C
- 360-degree rotating umbrella
- 360° drehbarer Schirm
- Parasol rotatif à 360°
- Parasol giratorio de 360°
- 360° draaibare parasol



- Peso
- Weight
- Gewicht
- Poids
- Peso
- Gewicht



- Apertura semplificata a spinta
- Easy push opening system
- Vereinfachte push-up Oeffnung
- Ouverture par poussée simplifiée
- Facil apertura tipo push-up
- Eenvoudig push-up systeem voor openen en sluiten



- Piastre cemento
- Cement slabs
- Kiesbetonplatten
- Dalles ciment
- Losteas de cemento
- Betontegel



- Inclinazione fino a 20°
- Inclination up to 20°
- Neigung bis zu 20°
- Inclination jusqu'à 20°
- Inclinación hasta 20°



- Volume (m³)
- Volume (m³)
- Volumen (m³)
- Volume (m³)
- Volumen (m³)



- Sezione stecche
- Rib section
- Strebenprofil
- Section baleines
- Sección brazos superiores
- Profiel baleinen



- Fodero
- Cover bag
- Schutzhuelle
- Housse
- Funda del parasol
- Afdekhoes



- Inclinazione fino a 60°
- Inclination up to 60°
- Neigung bis zu 60°
- Inclination jusqu'à 60°
- Inclinación hasta 60°



- Ø Palo (mm)
- Ø Pole (mm)
- Ø Mast (mm)
- Ø Mat (mm)
- Ø Palo (mm)
- Ø Mast (mm)



- Camino antivento
- Wind cap
- Windfang
- Souffle
- Tiraje superior para evitar efecto vela
- Windvang



- Doppia carrucola
- Double pulley
- Doppelter Seilzug
- Double poulie
- Doble polea
- Dubbele katrollen

**INOX**

- Viteria in inox
- Screws in Stainless steel
- Edelstahlschrauben
- Visserie inox
- Tornillos en acero inoxidable
- Schroeven van rvs



- Sezione sostegno (mm)
- Support section (mm)
- Mastprofil (mm)
- Section support (mm)
- Sección soporte (mm)
- Mast (mm)



- Stecca con sistema "easy change"
- Ribs with "easy change" system
- Streben mit "easy change" System
- Baleines avec "easy change" système
- Brazos superiores con sistema de sustitucion fácil
- Baleinen met het "easy change" systeem



- Sistema telescopico
- Telescopic system
- Teleskopsystem
- Système telescopique
- Sistema telescópico
- Telescoop systeem



- Tipo finitura della struttura/sostegno/ componenti
- Finishing for frame/structure/components
- Ausfuehrung des Gestells/der StrENtur/der Bestandteile
- Finition armature/structure/composants
- Tipo de acabado de la estructura/soportes/ componentes



- Colore dei componenti/stecche
- Component/Ribs colour
- Farbe der Bestandteile und Streben
- Couleur des composants et baleines
- Color de acabado de los componentes o brazos superiores



- Cataforesi
- Cataphoresis
- Kataphorese
- Kataphorèse
- Cataforesis
- Kataforese